

## Installation and Instruction Manual



Evolution House  
4-6 Kellet Close  
Wigan, WN5 0LP  
United Kingdom  
Ph: +44 (0) 1942 216 554  
Fax: +44 (0) 1942 216 562  
Web: [www.evolutionaqua.com](http://www.evolutionaqua.com)  
Email: [info@evolutionaqua.com](mailto:info@evolutionaqua.com)



# INTRODUCTION

Thank you for purchasing your Cetus Sieve. We are sure you will be delighted with its performance. Your Cetus will have been shipped to you either as a gravity or a pump fed unit.

## What's in the Box:

Figure	Part No	Description	Pump	Gravity
1	Cetus	Cetus	✓	✓
1.1	Cetus Screen 300	Cetus 300 micron screen	✓	✓
1.2	FE112L	4" - 4" (110-125mm) 90° rubber boot	✓	✓
1.3	FE85L	3" - 3" (122-68mm) 90° rubber boot	✓	✓
1.4	Cetuspipes	4" PVC pipe connecting piece	✓	
1.5	FE111-049	4" - 1.5" (110-50mm) rubber boot	✓	



Fig 1

CUT OUT  
To show  
inside parts



Fig 1.1



Fig 1.2.



Fig 1.3



Fig 1.4



Fig 1.5

## Basic Operation of the Cetus:

The Cetus is a self adjusting sieve which can be installed either gravity fed or pump fed, enabling the prefiltering of your pondwater before the water enters your current filter system. It also can be used as a standalone unit to remove leaves and other floating debris from your pond via a skimmer. It has been designed to efficiently and effectively remove large amounts of mechanical waste from your pond.

The Cetus is compatible with all filtration systems including the Evolution Aqua Nexus Eazy range. For gravity fed systems the Cetus has a weir which will automatically adjust to the flowrate of your pump. (Max flowrate 18,000 L/hr)

Figure 2 is a picture of a gravity fed Cetus showing the inlet and outlets.



Fig 2

When the Cetus is used in front of any other biological/mechanical filter the period in between cleaning will be extended. The biological process is improved by the removal of organic matter which would consume oxygen and leach ammonia and other compounds into the water.

# CETUS INSTALLATION

The Cetus needs to be installed on a solid level base so that it doesn't deflect under its own weight. It is recommended to use a 100mm thick concrete plinth, although decking or paving slabs can be used.

During installation a spirit level should be used across the metal plate on the weir to make sure the Cetus is level as shown in Figure 3.

This will ensure that the water flows evenly across the screen.



Fig 3

## Pipe Sizes

Pipe diameter determines the pressure loss within the pipe, so for flows where gravity is the driving force, large bore pipe (4" / 110mm) needs to be used.

Therefore in a gravity fed system, the inlet (the line from the bottom drain or skimmer) needs to be 4" (110mm) and also in a pump fed system the return line from the Cetus to your pond or filter needs to be 4" (110mm). When flows are under 10,000 L/hr it is possible to use 3" (90mm) pipe instead.

## Circulating Pump Installation

When installing your pump on a gravity fed system, the pump must be installed lower than the level of the outlet to prevent airlocks within the pump.

Also if there is any chance of back siphoning, a one way valve must be installed after the pump to prevent the Cetus filling with water.

## Technical Information

Max Flow	18,000 L/hr
Inlet	4" (110mm) Gravity 1.5" (50mm) Pump
Outlet	1.5" (50 mm) Gravity 3" (90mm) Pump Need 4" adapter when flow over 10,000 L/h
Waste Outlet	3" (90mm)
Height	945 mm
Length	850 mm
Width	570 mm
Screen Size	300 micron

## Cetus Gravity Fed System

With gravity fed installations, the Cetus needs to be installed so that the maximum water level in the Cetus is the same height as the maximum water level in the pond. To do this, the top of the Cetus needs to be installed 20mm above the pond water level as shown in figure 4 below.

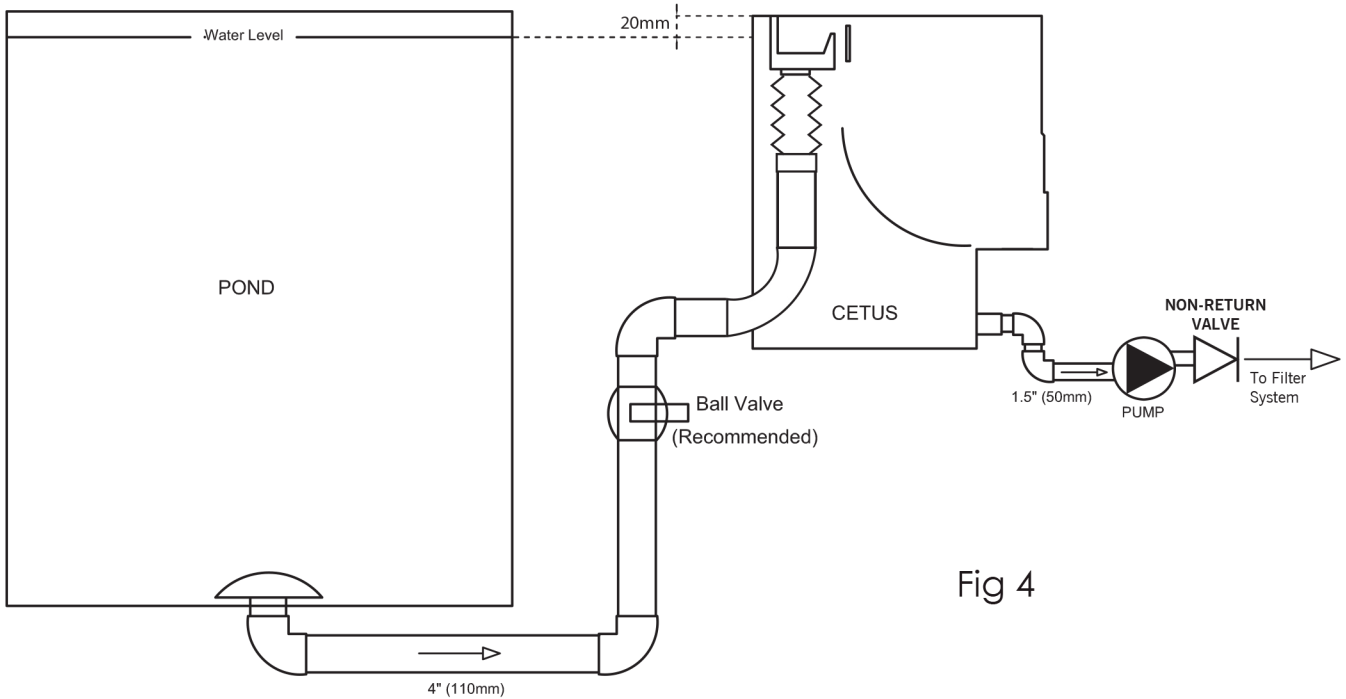

Fig 4

Figure 4 shows the standard way of installing a gravity fed Cetus. Figure 4a shows a gravity fed installation on a skimmer line.

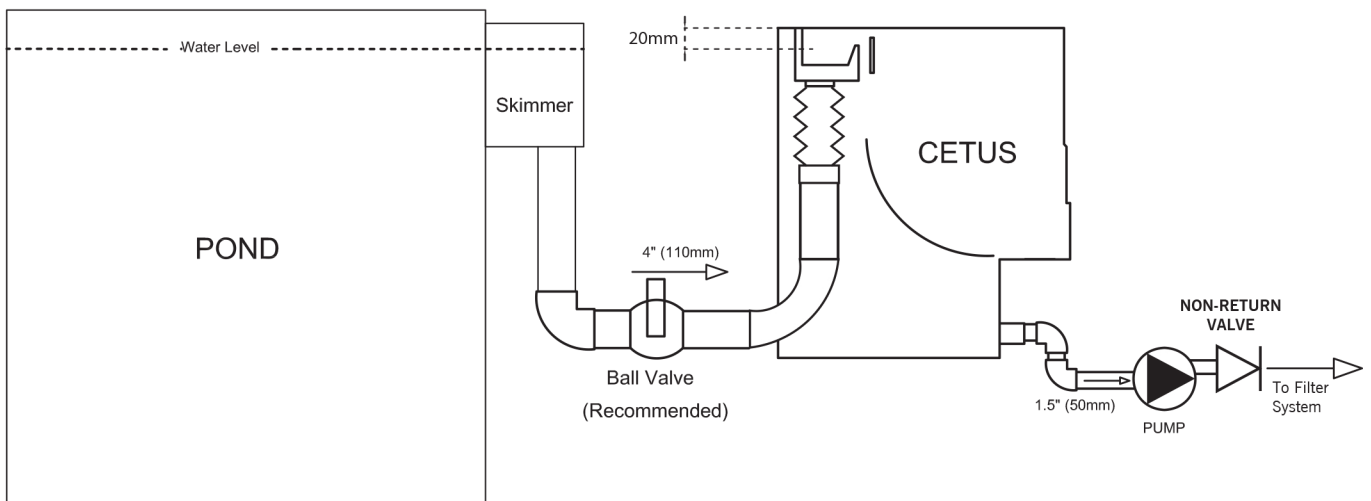

Fig 4a



# PUMP FED - INSTALLATION

The Cetus when installed as a pump fed unit, needs to have the extra components (Figures 1.4 and 1.5) connected as in Figure 5.

This will enable a 1.5" (50mm) hard pipe or hoesail for flexible pipe to be fitted, connecting your pump to the Cetus.

When pump fed, the Cetus needs to be installed above water level as shown in figure 6 below.



Fig 5

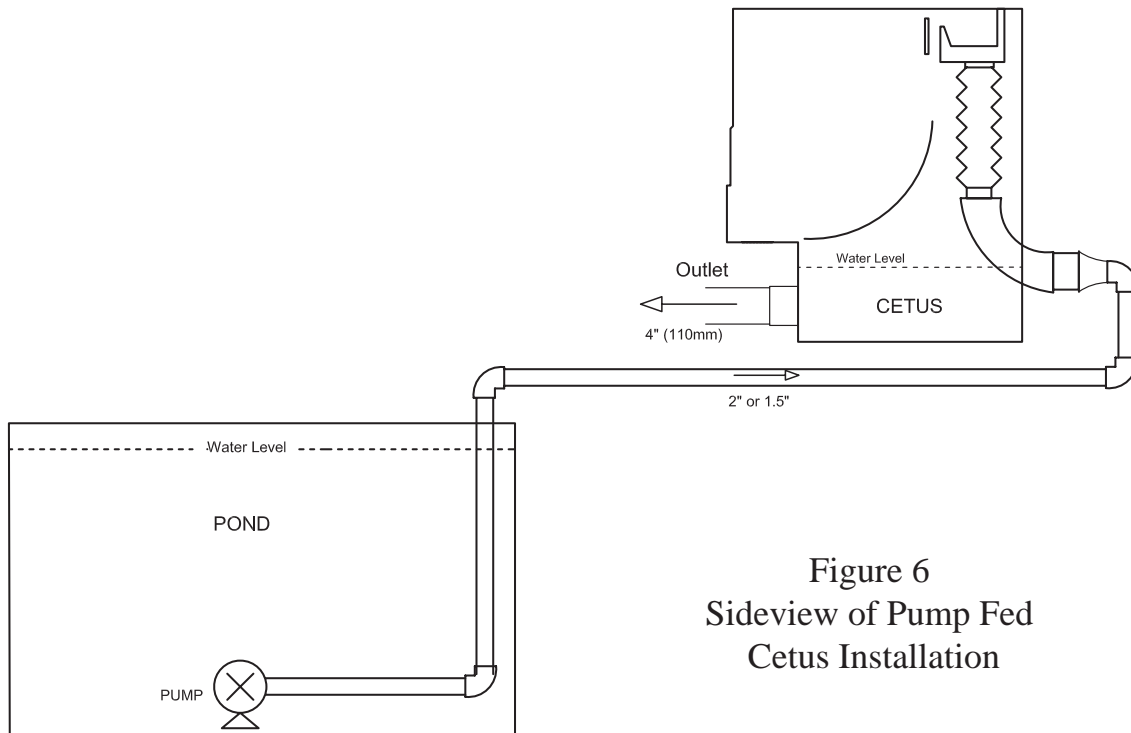

Figure 6  
Sideview of Pump Fed  
Cetus Installation

Figure 6 shows the standard way of installing a pump fed Cetus.

While figure 6a shows the way of installing a pump fed Cetus on a skimmer line.

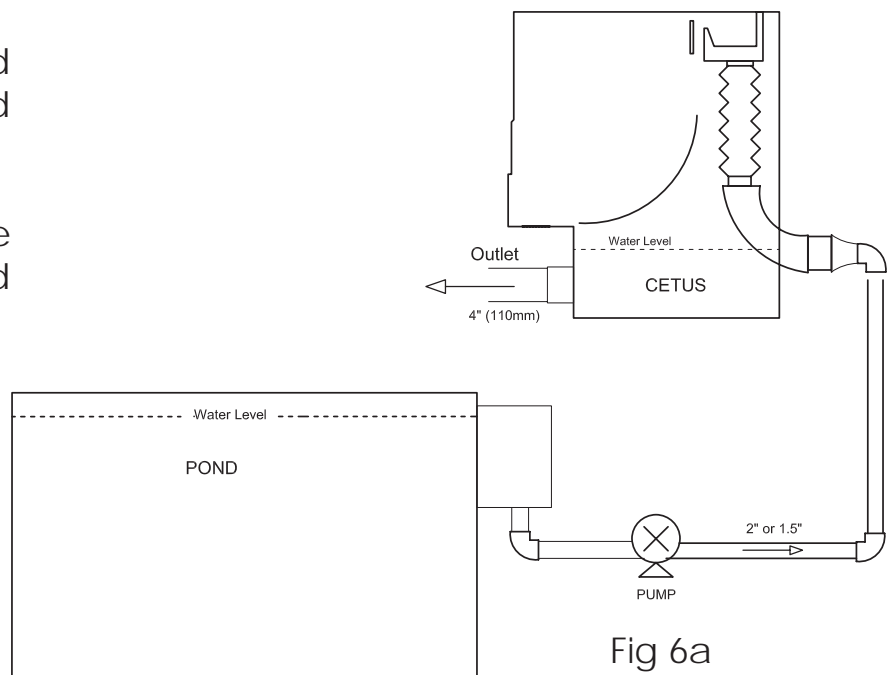
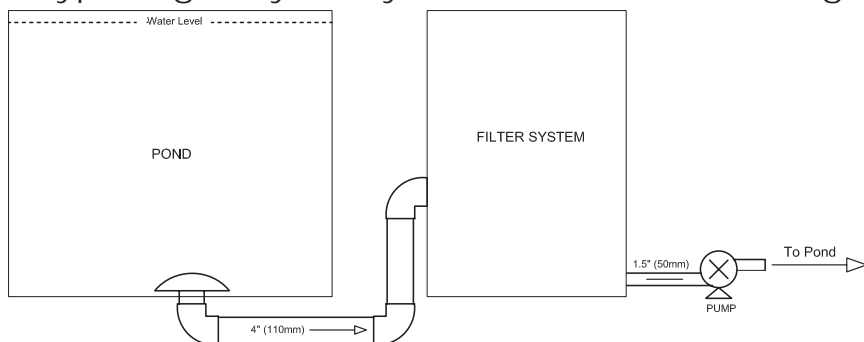

Fig 6a

# DUAL GRAVITY FED - INSTALLATION

This method of installation enables the user to prefilter the pond water through the pond sieve prior to being delivered into the next stage of filtration.

A typical gravity fed system is shown below in figure 7



To improve a typical gravity fed filter, a gravity pond sieve could be installed prior to the gravity fed filter as shown below in figure 8

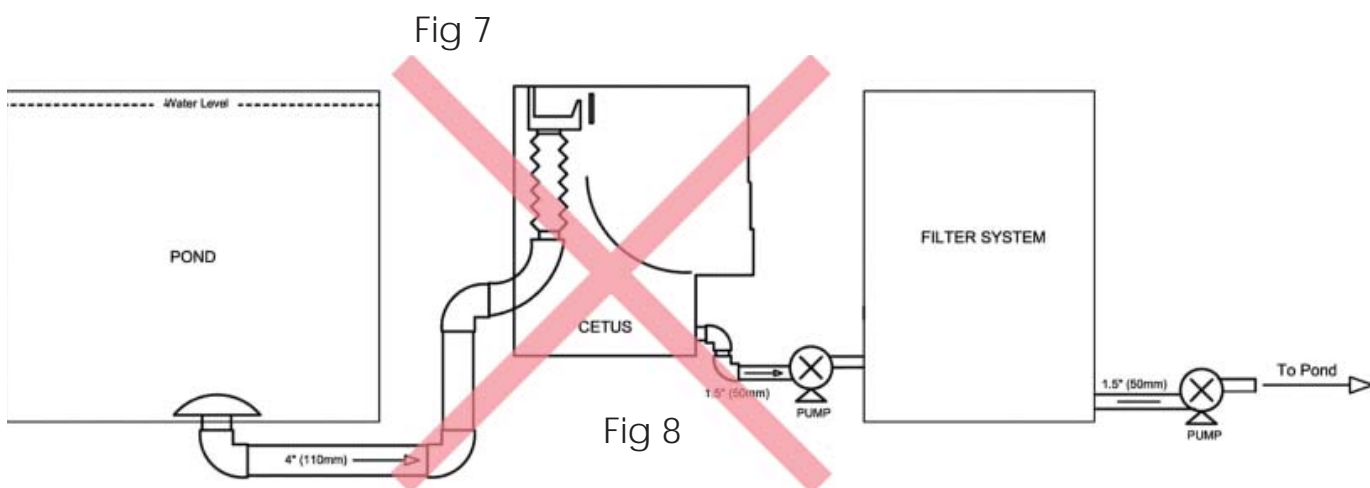

Two pumps would be used in this application. One for pumping the water from the pondsieve to the filter and the second pump for pumping water from the filter back to the pond. **The major problem** with this setup is that it is almost impossible to balance the running speeds of the two pumps. This setup can cause the gravity fed filter to overflow or have the water emptied from the filter.

## New Dual Gravity Fed System.

Figure 9 below shows how this system can be installed with a balance pipe to allow the flow difference in pumps to equalise.

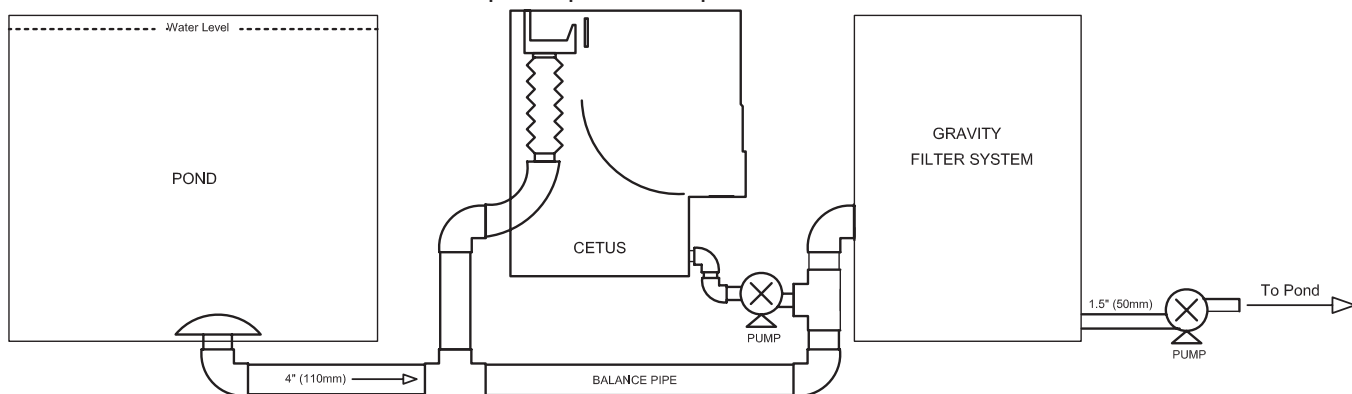

Fig 9

The 4" (110mm) pipe between the Cetus and the filter will allow water to pass in the direction of the higher demanding unit (it is recommended that the pump from the Cetus has a higher flowrate than the pump from the filter).

## DUAL GRAVITY FED - INSTALLATION

To explain this system in better detail, diagram 10 below is a top view schematic of how to install a dual gravity fed Cetus and filter. The following points relate to the flows within the system

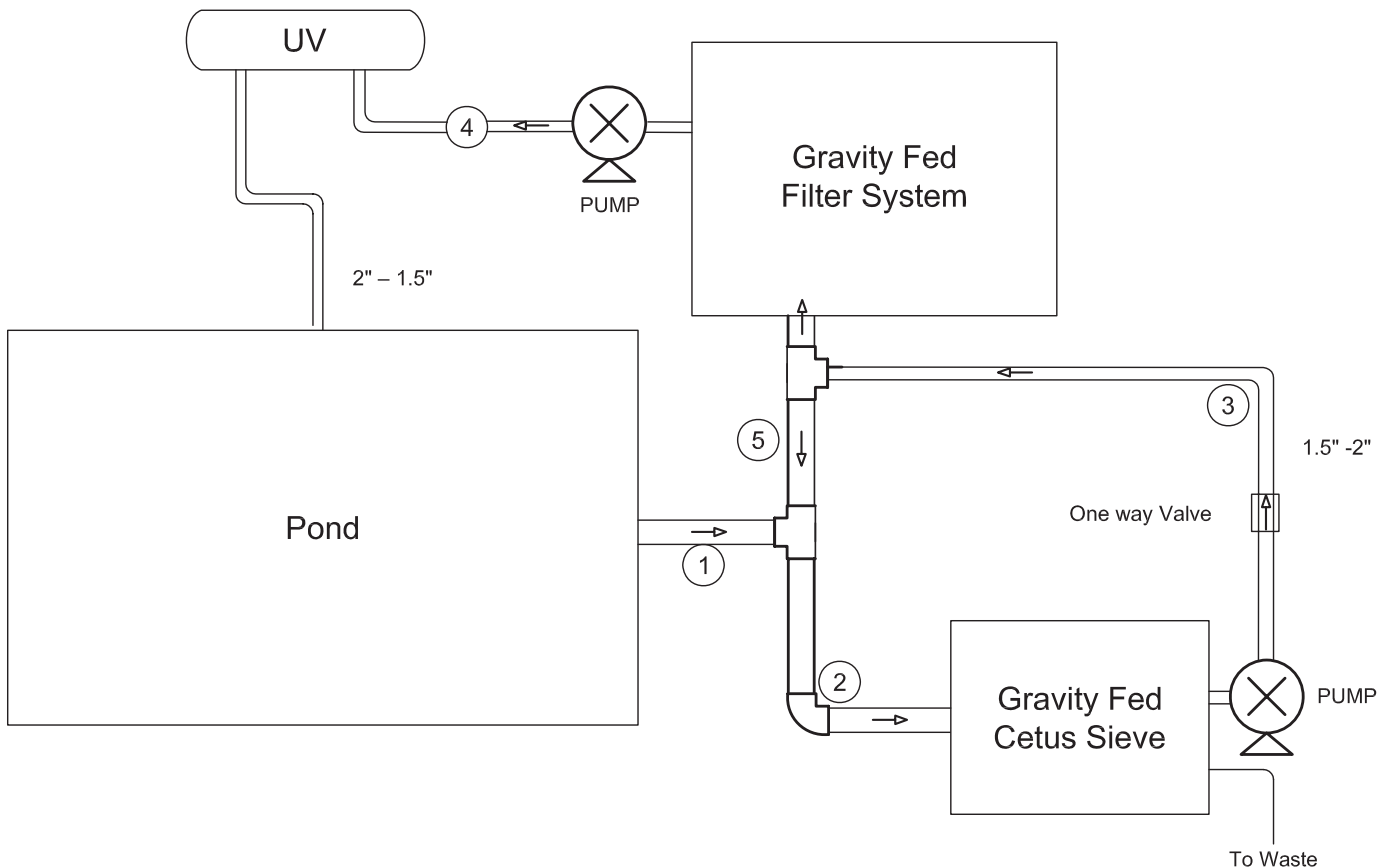

Fig 10

- 1) Water leaves the pond via a 4" bottom drain and travels to the first T-piece
- 2) Water then travels to the Cetus
- 3) Water is pumped from the Cetus to the filter
- 4) Water is pumped from the filter back to the pond
- 5) Excess water flows through the balance pipe back to the Cetus

There are huge benefits to be gained by utilising this **new evolution in pond filtration**

- Running these units in this configuration maximises the interval between cleans
- Either unit can be switched off to carry out maintenance without affecting the other
- Both the Cetus and the filter can run independently of the other unit

N.B. We would like to express our thanks to Malcolm Green of Koi Water Garden Limited for his help in this Dual Gravity setup